

**CONVEYOR GUIDE CO.,LTD.**

**บริษัท คอนเวเยอร์ ไกด์ จำกัด**

**HS-2800 C Technical Data Sheet**

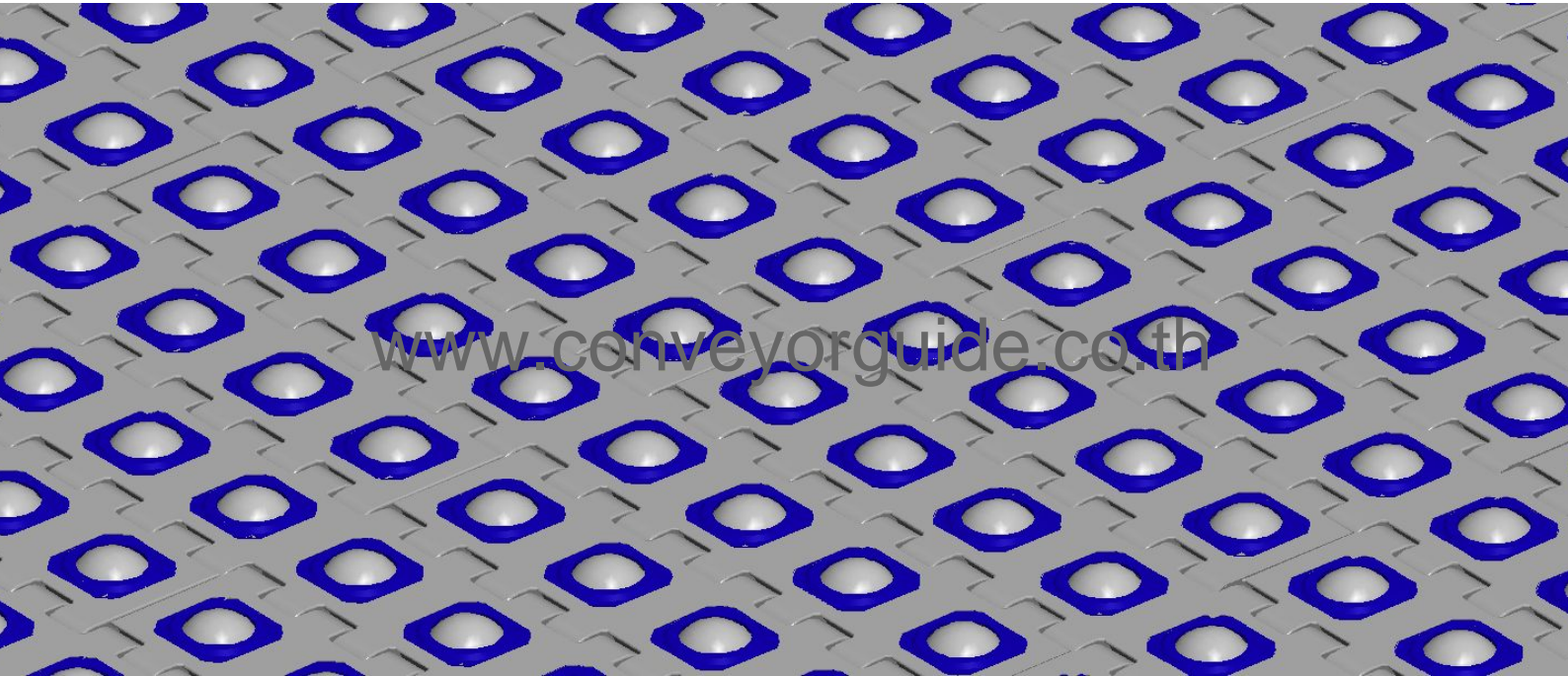

Pitch: 25mm  
 Minimum Width: 179.5mm  
 Open Area: 0%  
 Approved: FDA  
 Rod: Ø 4mm  
 Flight: No  
 Side Guard: No  
 Curve No

www.conveyorguide.co.th

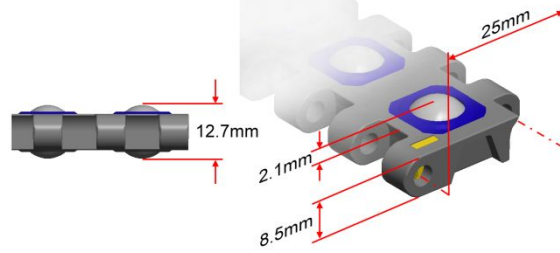

### Data

Belt Material	Belt Strength Kg/M (BW)		Temperature		Belt Weight (Kg/M <sup>2</sup> )
	Straight	Curve	°C (min.)	°C (max.)	
Polypropylene	800	--	1	60	7.2
Acetal	950	--	1	75	9.6

BW – Belt Width

### Color Table

Polypropylene					Polyethylene					Acetal					Nylon									
W	G	N	DB	B	W	G	N	DB	B	W	G	N	DB	B	W	G	N	DB	B					
●	●									●									●					

W-White, G-Gray, N-Nature, DB-Dark brown, B-Blue

### Friction Table

Belt Material	Friction Wear strips & Products							
	UHMW	HDPE	Steel	Glass	SUS	Plastic	Cardboard	Aluminum
Polyethylene	0.32	0.24	0.15	0.09	0.13	0.08	0.15	0.25
Polypropylene	0.13	0.11	0.26	0.19	0.31	0.16	0.21	0.41
Acetal	0.11	0.09	0.27	0.16	0.26	0.15	0.19	0.28
Nylon	0.18	0.13	0.25	0.16	0.26	0.16	0.19	0.27

SUS – Stainless Steel

Brand Name	Intralox	Emerson	Rexnord	MCC	Easecon	Habasit	KVP	Regina
Series & Type	400	2253						

The above content is only for reference, match or not, please make your own judgment.

Equivalent type with other Brand

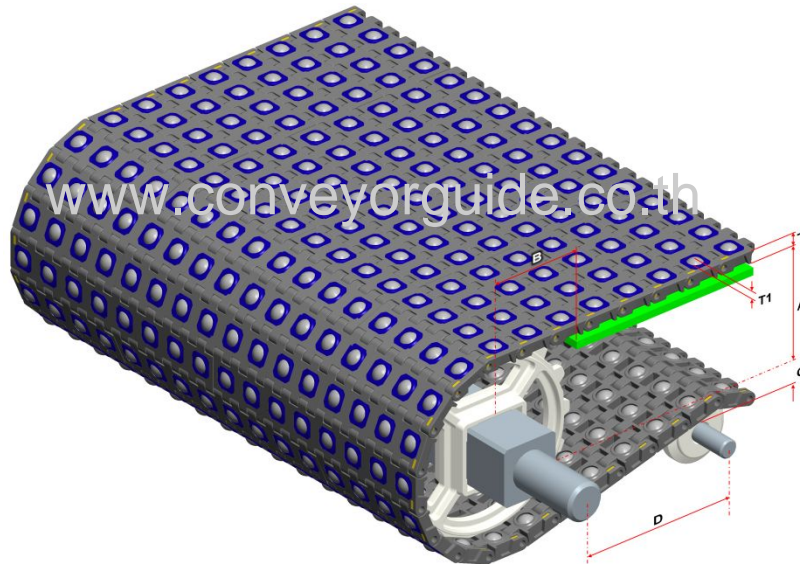

Conveyor Frame Dimensions						Unit : mm
No. Teeth	A ( Min.)	B ( Min.)	C ( Max.)	D ( Min.)	T	T1
16	60	60	47	200	8.5	2.1

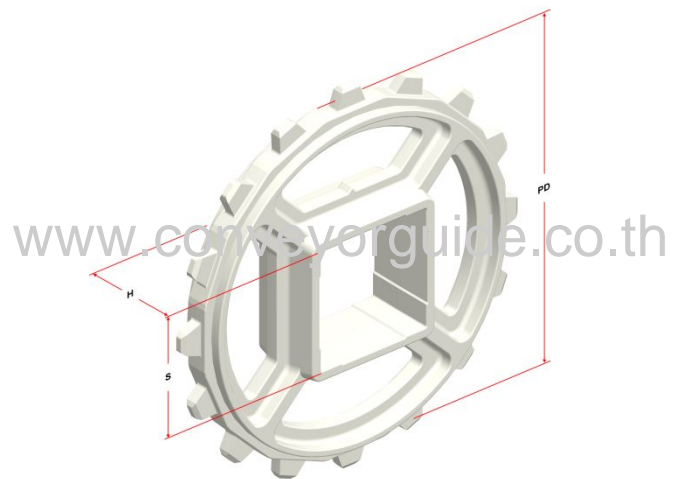

Sprocket Dimensions					Unit: mm
No. Teeth	PD	S	D	H	K
16	128	40.5	--	25	--

## **The origination of HS-2800 Universal Ball Belt**

HS-2800 Universal Ball Belt is developed by HONGSBELT for Logistics, Sorting, Stacking and other conveying requirements. Pitch of the belt is 25mm, with durable and thinner characteristics, it sets an new standard for the redirection and divert of products in logistics industry.

It allows a very large degree of flexibility to do the planning of logistics transportation system for you by using HS-2800. All applications requiring products transverse transfer, sidesway, orientation, diverting, or even reduce/increase the interval of products by emerging motion of multi-speed conveying can be realized by HS-2800. Product movement is controlled by driving balls with a perpendicular secondary conveyor underneath HS-2800.

### **Intensive balls of HS-2800**

In addition to the advantage of light-weight, HS-2800 help you save cost and reduce waste of space in design of conveying system, and allow the designers designing more light-weight conveying system with elastic usage.

Balls of HS-2800 universal ball belt is very intensive, there are 20 balls distribute in each 100 square millimetre, this data is equivalent to an area same with a business card is supported by 12 balls, so HS-2800 universal ball belt is suitable for any scale of distributing, sorting and elimination after selection.

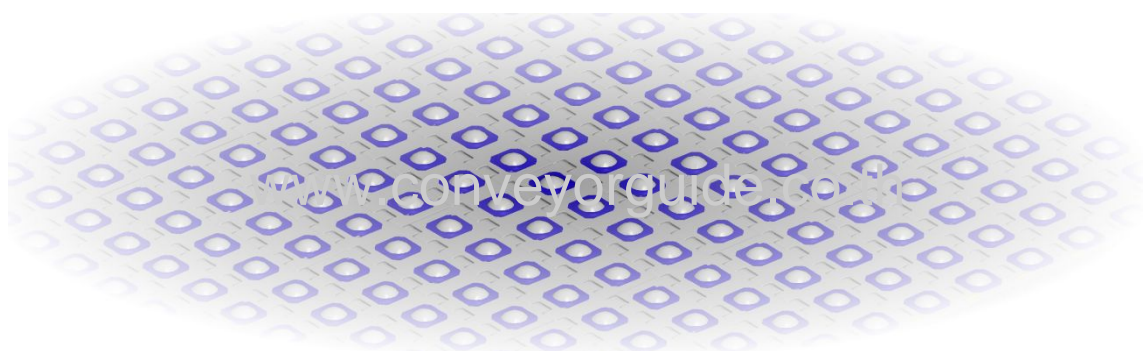

## Design and requirements for quality of HS-2800

Pitch of HS-2800 universal ball belt is 25mm, total thickness is 8.5mm; balls of HS-2800 are made from super abrasion-resistant Acetal material, and the diameter of it is 12.7mm. HS-2800 universal ball belt have strict requirement on precision of the balls, and the balls' roundness error must be controlled within 0.02mm to insure smoothly conveying.

In response to the requirements of various transport environment, PP (Polypropylene) and POM (Acetal) material are selectable for belt; and POM, PP, ceramics, chromium-plating steel etc. material are selectable for the balls, which can totally satisfy your needs of transportation.

conductive material POM – AS can be added in belt material of HS-2800 to reduce static accumulation. It will be more effective if intall static brush or other discharge device in area where static electric charge is generated.

## Application of HS-2800

### ■ Transverse Transfer

A driver is installed under HS-2800 to change the direction of product into transverse by dynamic friction. When the products arrive in scope of the driver, they will do transverse movement towards right or left side, which is perfect for sorting, elimination after selection, distributing and other projects of logistics transportation.

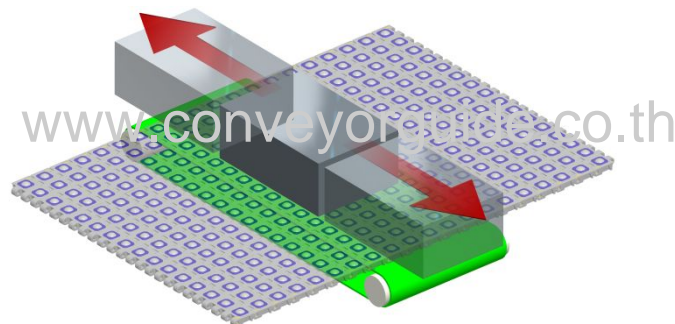

### ■ Multi-Speed

Static friction device are setted under HS-2800, so balls will get double speed when go through this area, which enlarge the distance between products.

The advantage of multi-speed movement is that the conveyor belt' speed is magnified at least 50%. With super wear-resistant balls as propulsion, the conveyor belt is allowed to run slowly to reduce the consumption and attrition of conveyor belt, and lower the noise in factory.



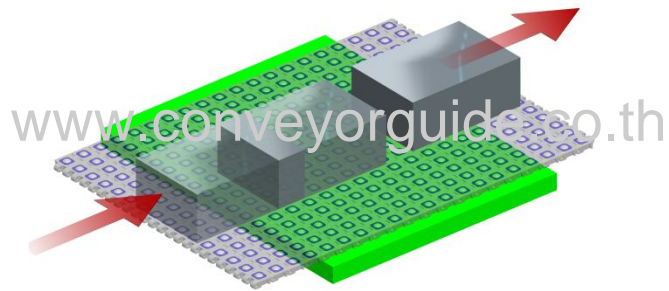

#### ■ Dynamic Turning

Two drivers are installed under HS-2800 and are parallel to the right and left side of conveyor belt and do inverse running, when balls of conveyor belt get in contact with this area, the products will do turning movement beyond  $90^\circ$  . It suitable for work flow which has request in direction, and widely used in procedure of reversing before stacking, alignment etc.

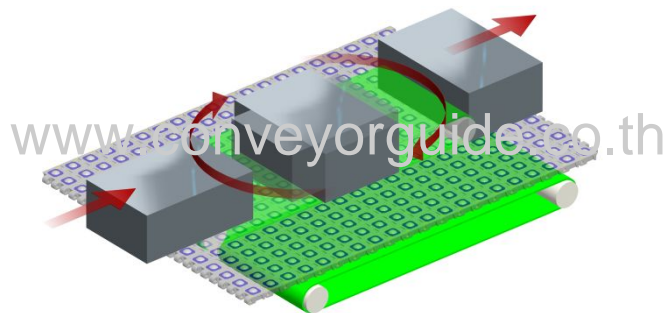

#### ■ Circular Turning

A disc type driver is installed under HS-2800, combined with electronic control, sensor etc. when the products pass through the set point, the conveyor belt will be suspended and the disc type driver starts to work, now the products on the belt will circle more than  $180^\circ$  in scope of disc type driver, when the products arrive at side of interpretation, the conveyor belt will restart and continue to go forward. it is suitable for procedure of CCD detection, diversion etc.

